

Montage / Mounting mini

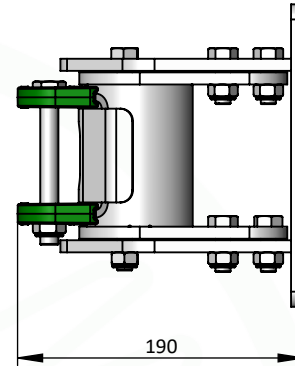

Montage / Mounting maxi

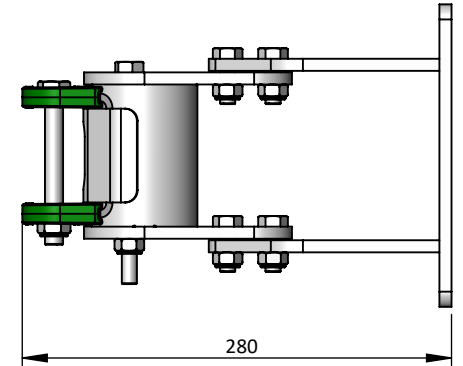

Montage entre / Mounting between HEA200

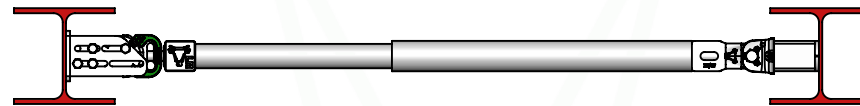

Broche anti-passage / Bare pin BA9931
(trou à re-percer / hole to re-drill Ø15)

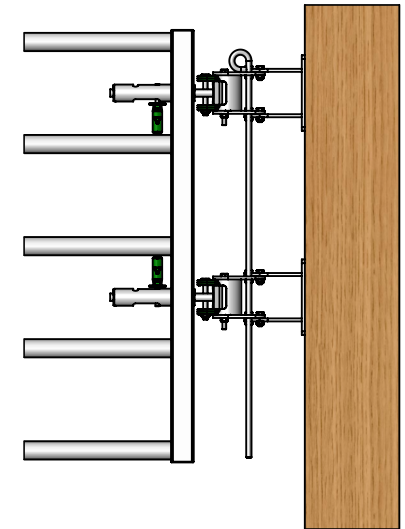

Montage / Mounting 45°

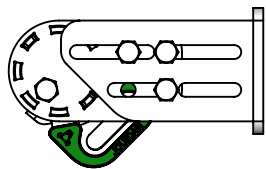

Montage / Mounting 90°

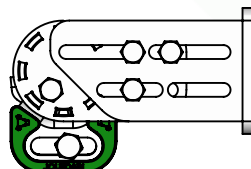

Montage / Mounting 135°

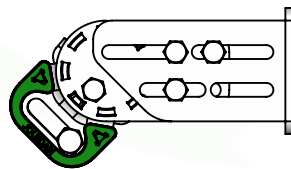

Montage / Mounting 180°

