

TR4016

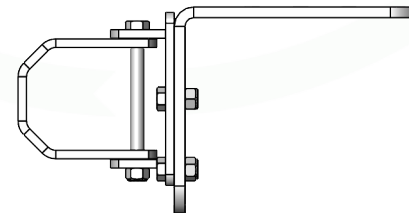

TR9903

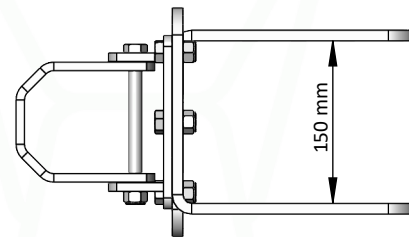
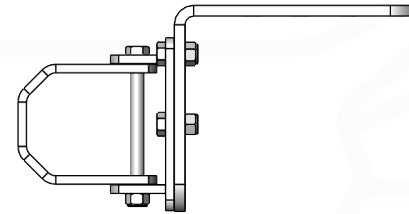
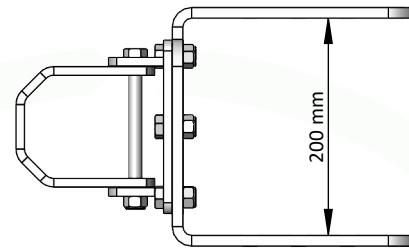
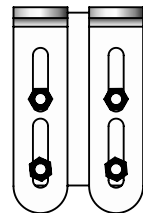
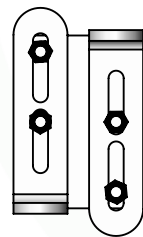
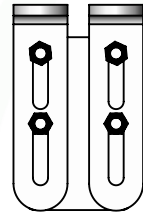
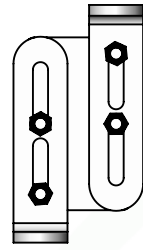
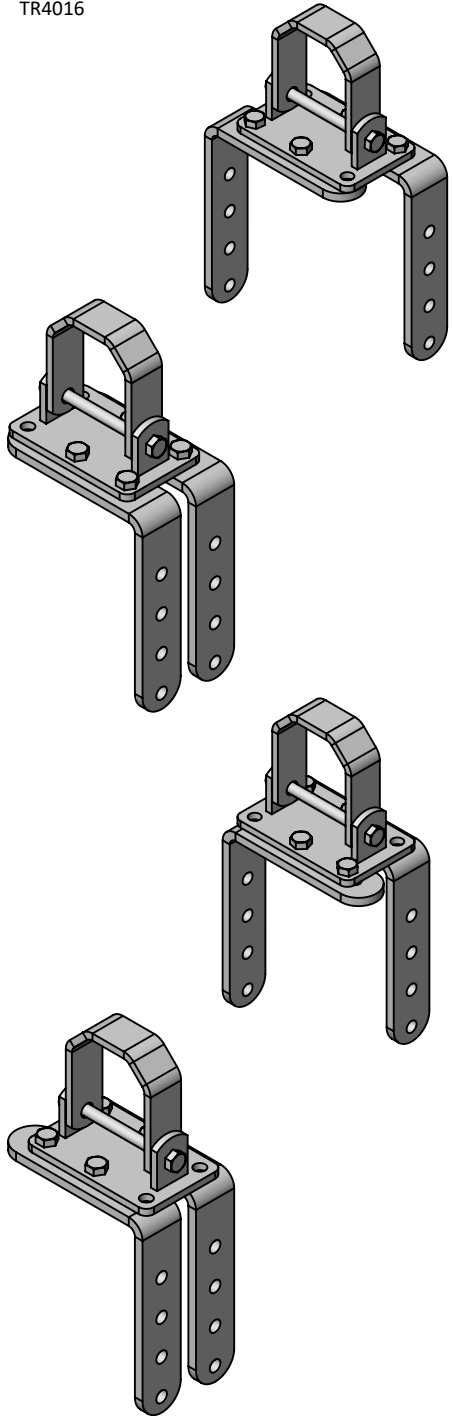
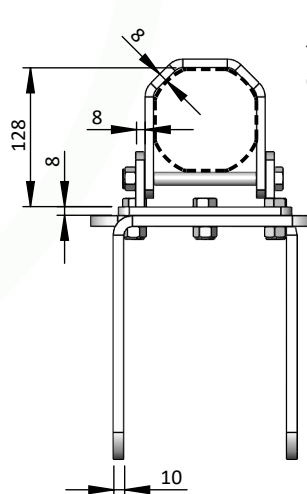
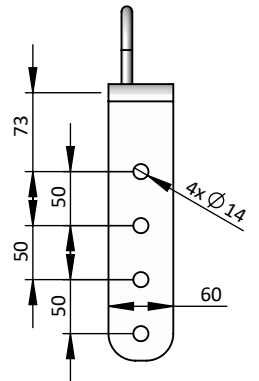
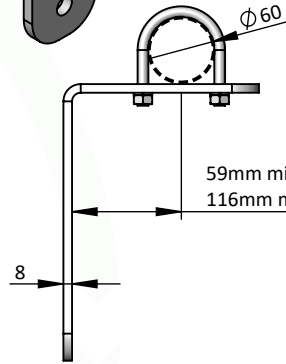
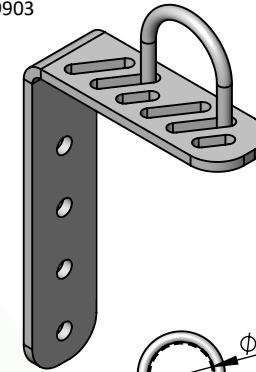

Trèfle 102
Octogonal 102

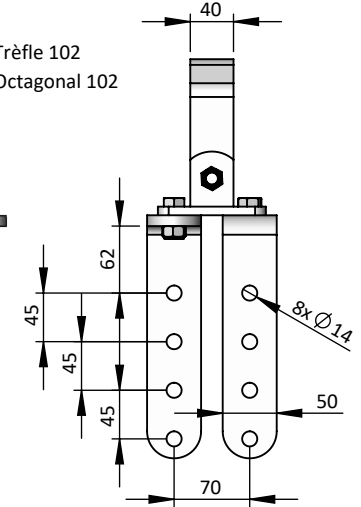

REINFORCEMENT FOR WALL (15 TO 20CM)

Schéma technique donné à titre indicatif, produit pouvant être modifié sans préavis. Nos produits sont brevetés et sont la propriété de JOURDAIN SAS. Consultez nos CGU et instructions de sécurité sur notre site <https://www.jourdain-group.com/fr/documentation>

Technical diagram given for information only, product subject to change without notice. Our products are patented and the property of JOURDAIN SAS. Consult our GTC and safety instructions on our website <https://www.jourdain-group.com/fr/documentation>

DT

18/12/2024

