

5034592

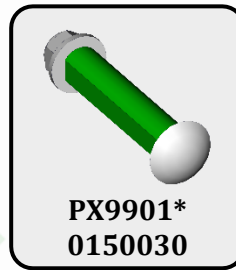

PX9901*
0150030

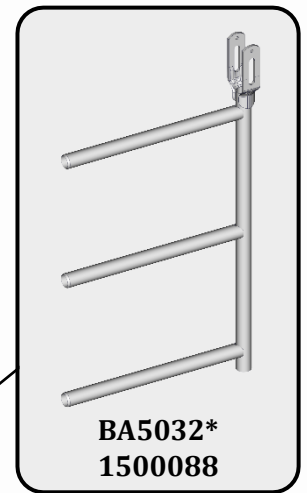

BA5032*
1500088

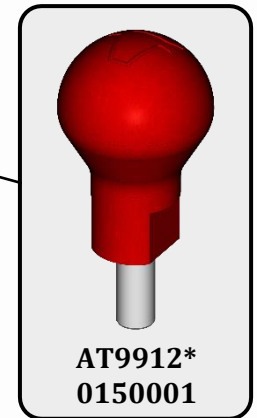
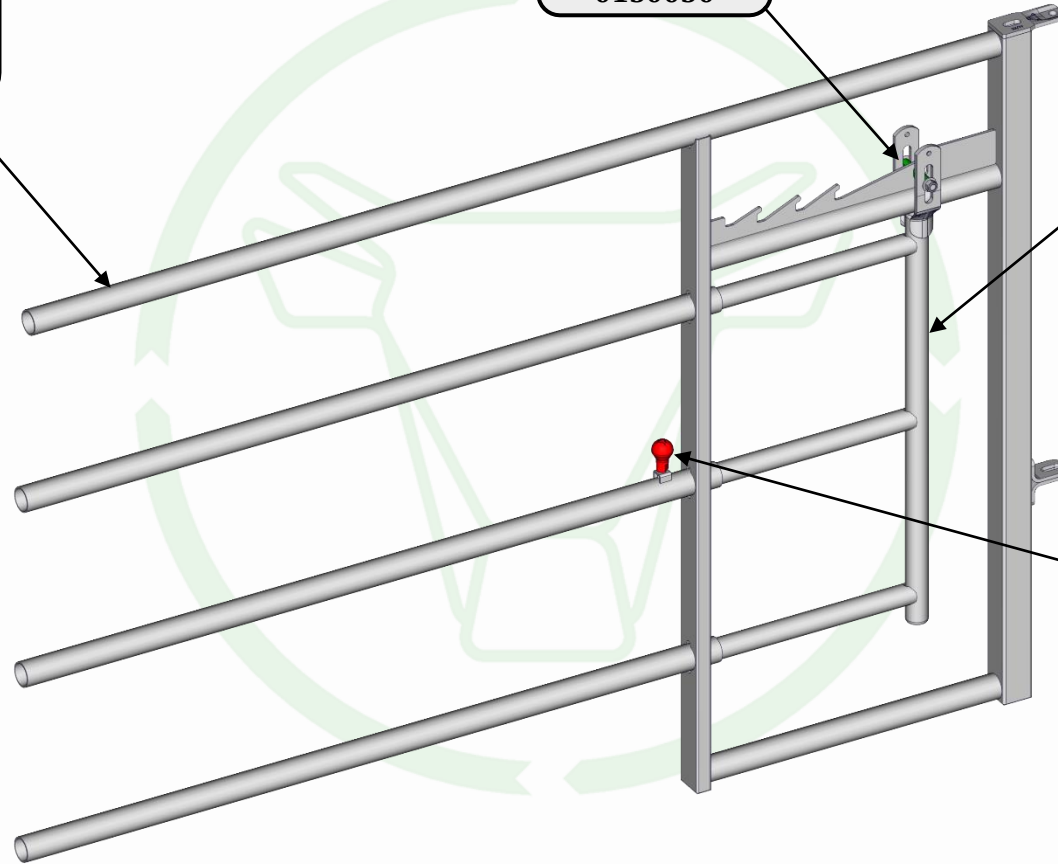

AT9912*
0150001



JOURDAIN
www.jourdain-group.com

BA2097 - FRONT EX4 WITH CALF CREEP

THIS DOCUMENT IS THE EXCLUSIVE PROPERTY OF JOURDAIN SAS, IT IS PROVIDED ON A CONFIDENTIAL BASIS.
IT MUST NEITHER BE COPIED, NOR DISCLOSED TO A THIRD PARTY WITHOUT OUR WRITTEN AUTHORISATION

FTB

27/11/2023