

CC0825 - HEADLOCK GOAT 8P.-2.50M L.2.49M

THIS DOCUMENT IS THE EXCLUSIVE PROPERTY OF JOURDAIN SAS, IT IS PROVIDED ON A CONFIDENTIAL BASIS. IT MUST NEITHER BE COPIED, NOR DISCLOSED TO A THIRD PARTY WITHOUT OUR WRITTEN AUTHORISATION

FTB

18/01/2022

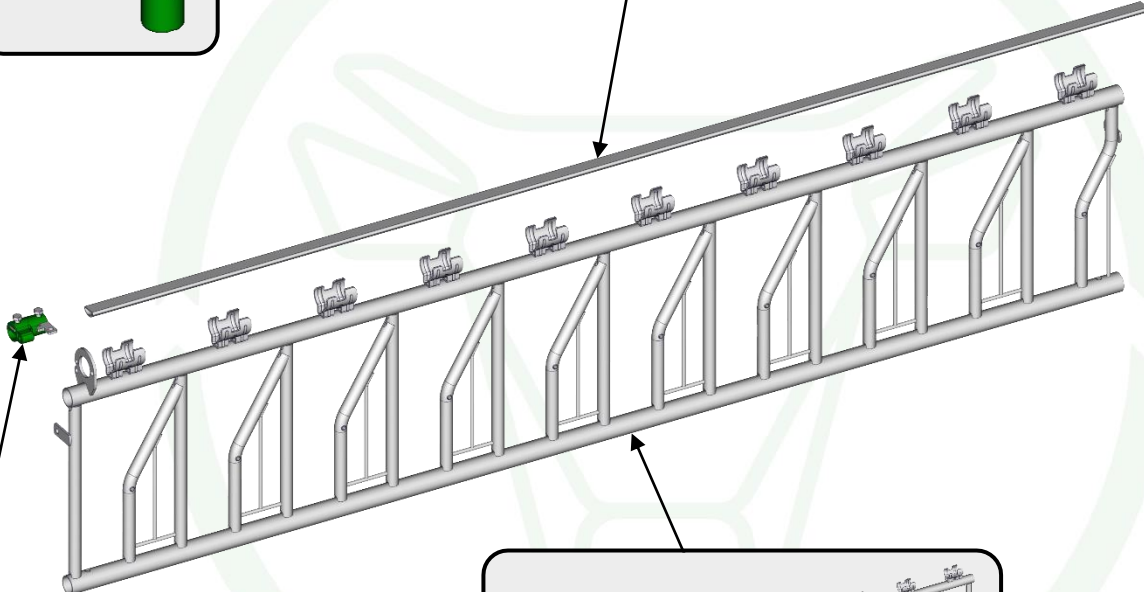
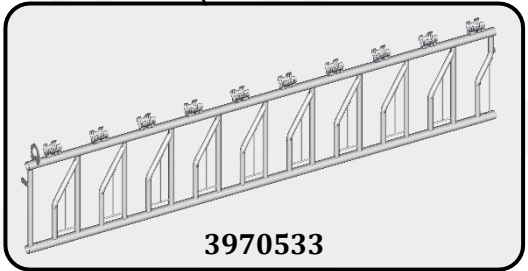
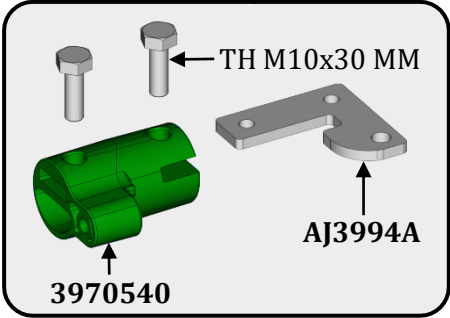
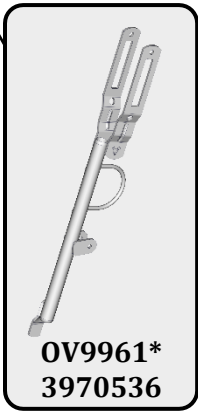
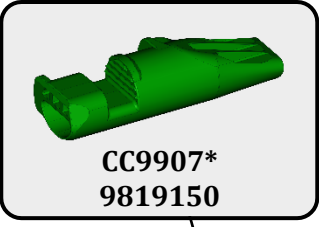
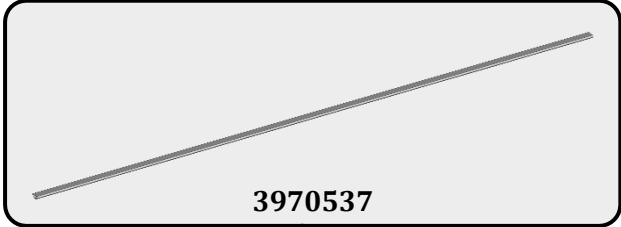
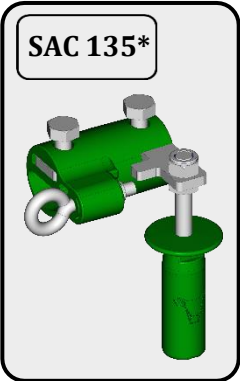
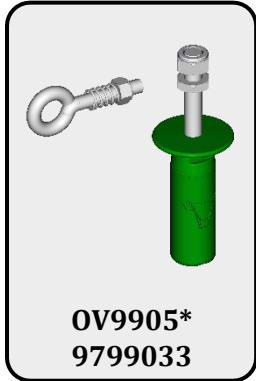

CC1025 - GOAT KID HEADLOCK 10P.-2.50M L.2.49M

FTB

THIS DOCUMENT IS THE EXCLUSIVE PROPERTY OF JOURDAIN SAS, IT IS PROVIDED ON A CONFIDENTIAL BASIS. IT MUST NEITHER BE COPIED, NOR DISCLOSED TO A THIRD PARTY WITHOUT OUR WRITTEN AUTHORISATION

18/01/2022

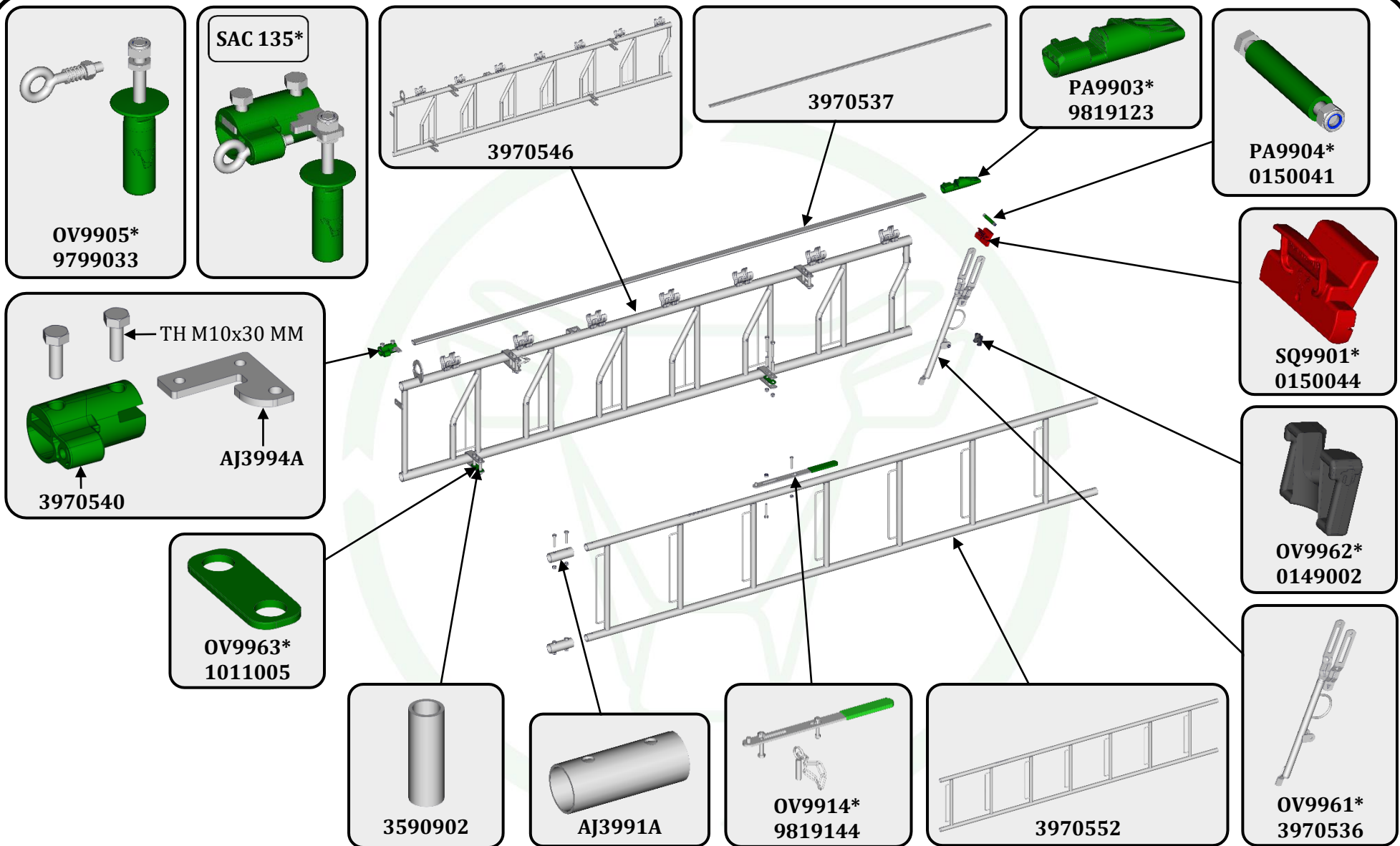

OV0725 - SHEEP HEADLOCK 7P.-2.50M L.2.49M

FTB

THIS DOCUMENT IS THE EXCLUSIVE PROPERTY OF JOURDAIN SAS, IT IS PROVIDED ON A CONFIDENTIAL BASIS. IT MUST NEITHER BE COPIED, NOR DISCLOSED TO A THIRD PARTY WITHOUT OUR WRITTEN AUTHORISATION

18/01/2022